

SECONDA CONFERENZA NAZIONALE
SULL'EFFICIENZA ENERGETICA

Trigenerazione: Efficienza Energetica 365 giorni all'anno

Ing. Marina Mestroni
Wärtsilä Italia S.p.A.

Roma 19 Ottobre 2010

AGENDA

- W-Power in Italy
- PHC - Power Heat and Chilling
- Linate Airport Case
- Conclusions

AGENDA

- W-Power in Italy
- PHC
- Linate Airport Case
- Conclusions



WÄRTSILÄ

Focus on Renewables

Italgreen Energy - Monopoli

Prime movers	6x 18V46
Electrical output	102.457 kWe
Thermal Output	41.796 kWth
Steam turbine combined cycle	12.653 kWe
Total Efficiency	50%



AGENDA

- W-Power in Italy
- PHC - Power Heat and Chilling
- Linate Airport Case
- Conclusions

CO₂ Emission for EU commission

Table 5: Total-cycle specific CO₂ emissions for state-of-the-art generating technologies [24] , [25].

technology	Minimum value g/kWh	Maximum value g/kWh	Reference this report g/kWh
Coal steam	815	1000	900
Gas steam	635	635	635
GTCC	356	472	400
Gas cogen	220	275	250
nuclear	6	26	15
Solar PV	50	300	200
Hydro	3	18	10
Wind	5.5	37	25

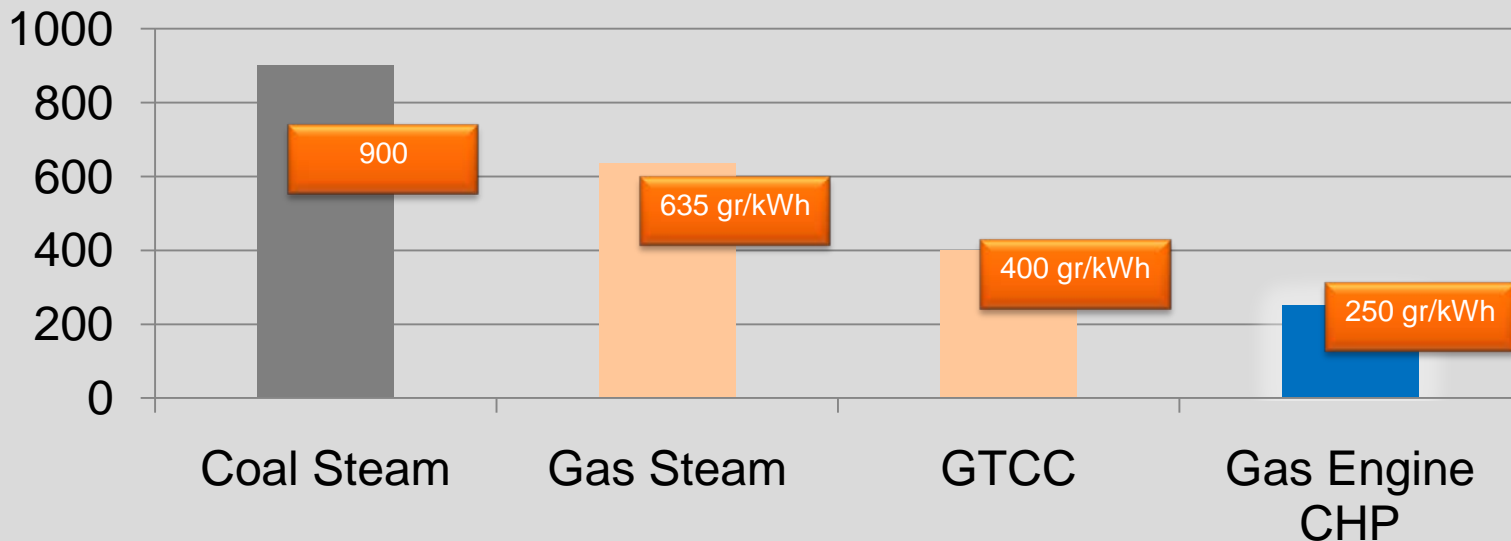

An efficient Portfolio

Genset	W20	W32	W34	W46	W50DF
El. Power (MW)	1,0 - 1,5	2,6 – 8,9	3,8 - 8,7	8,5 - 22,3	16,6
El. Efficiency	42%	45,5%	46,5%	47%	47,3%

Combination of HIGH EFFICIENCY and LOW EMISSION Power Plants

POWER HEAT and CHILLING generated close to consumer causes LOWER TRANSMISSION LOSSES shorter piping routes

FLEXIBLE OPERATION for changes in Power/Heat/Chilling Demand

FLEXIBILITY IN FUELS, use of renewables

Maximized PLANT AVAILABILITY in all operating situations

Optimized plant size (MODULARIZATION)

Efficiency 365 days per year

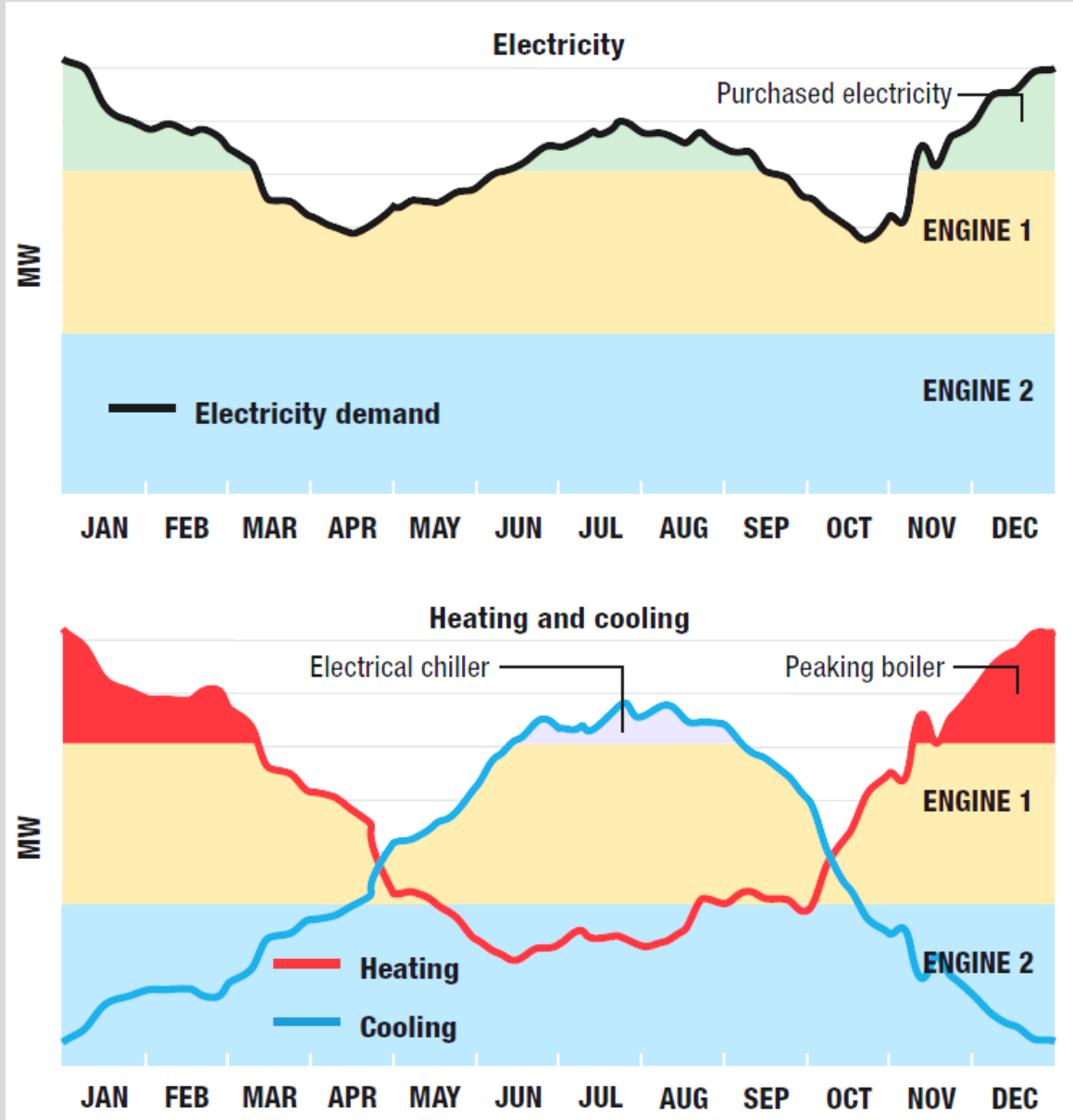

One step ahead with absorption chillers

DIRECT EXHAUST GAS DRIVEN CHILLER

Engine type..... Wärtsilä 20V34SG

Electric power..... 8 730 kWe

Chilled water or district cooling 4 713 kWch/1 340 TR

Data is given at 100% load at an ambient temperature of 25°C and methane number of 80, p.f.=0.8. According to ISO 3046:1995.

Max abs-chiller COP=1.0

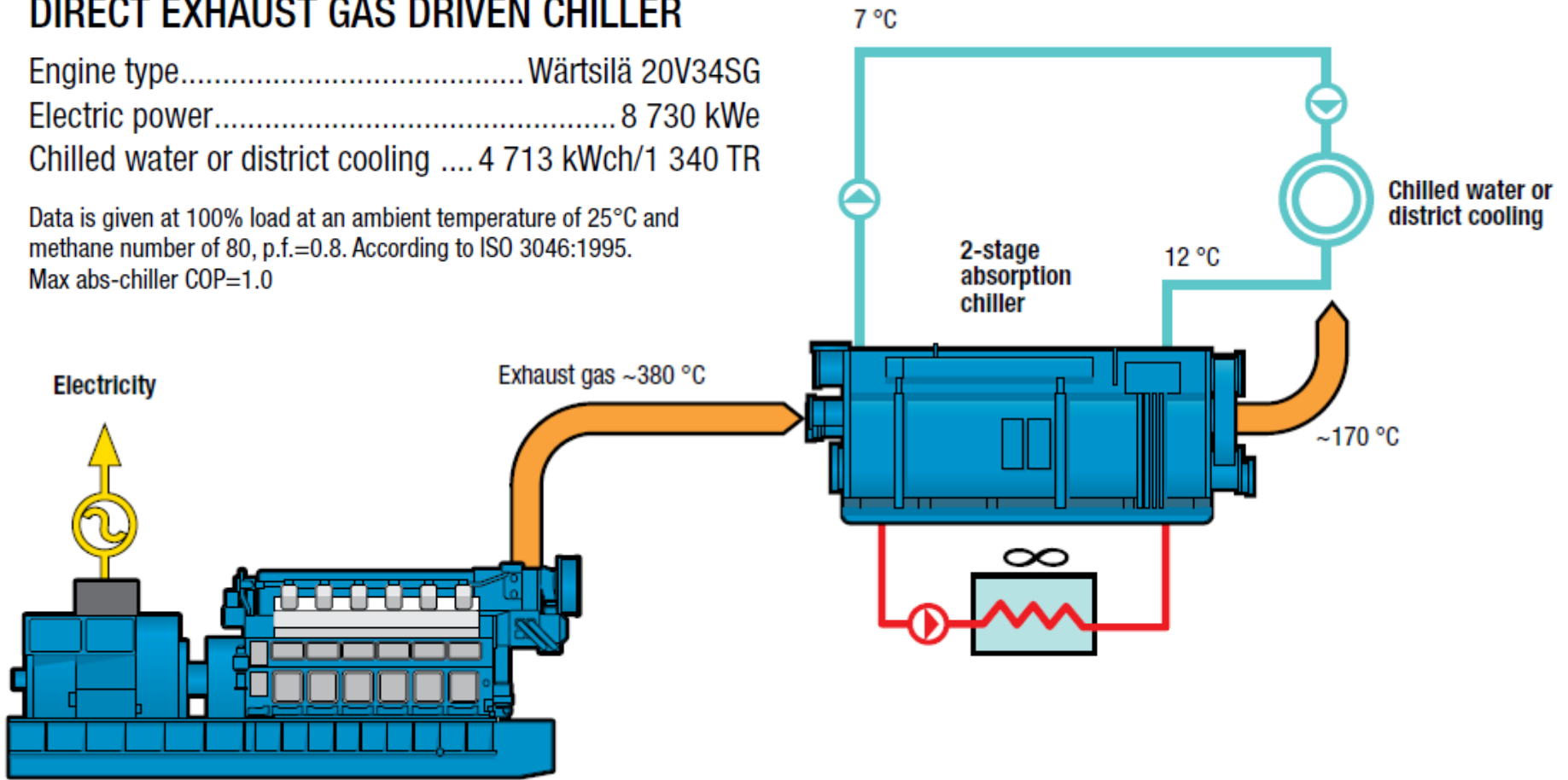

One step ahead with absorption chillers

EXHAUST GAS AND HOT WATER DRIVEN CHILLER

Engine type..... Wärtsilä 20V34SG

Electric power..... 8 730 kWe

Chilled water or district cooling... 5 892 kWch / 1 675 TR

Data is given at 100% load at an ambient temperature of 25°C and methane number of 80, p.f.=0.8. According to ISO 3046:1995.

Max absorption chiller COP = 1.0

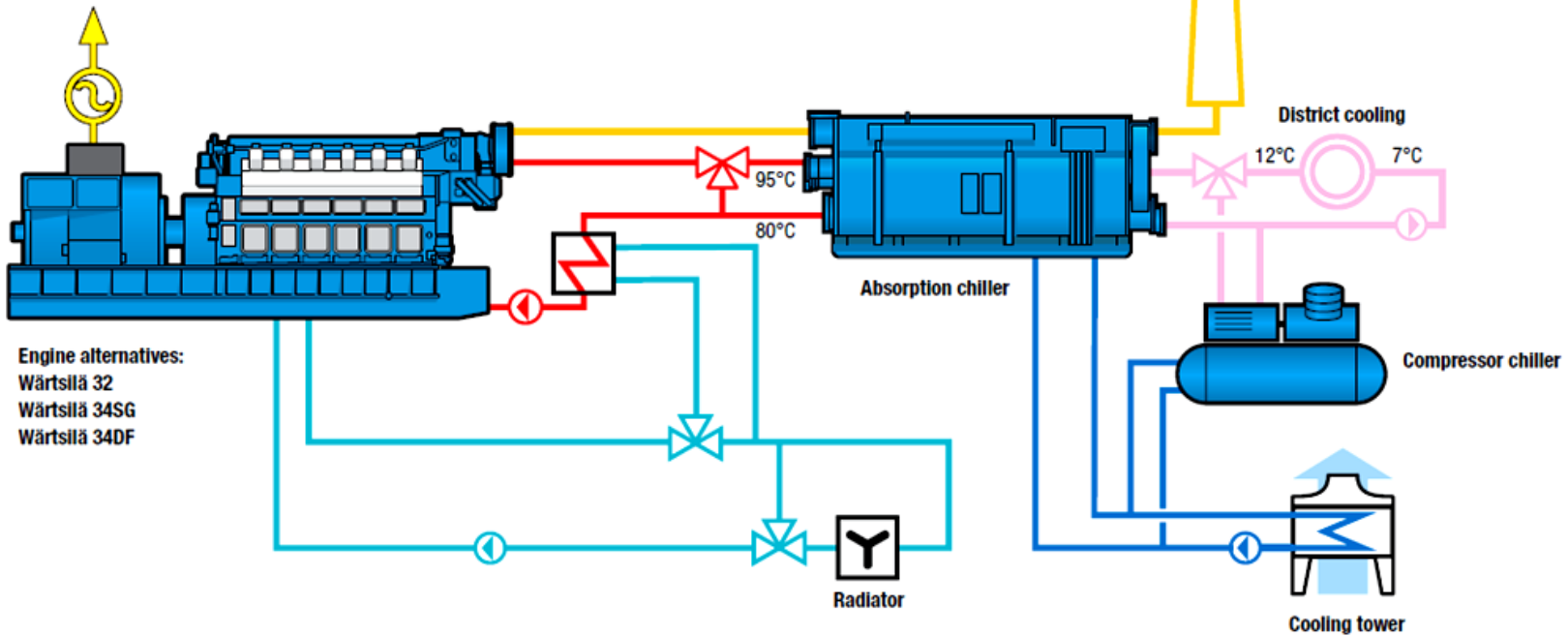

One step ahead with absorption chillers

HOT WATER DRIVEN CHILLER

Engine type..... Wärtsilä 20V34SG
Electric power..... 8 730 kWe
Max hot water or district cooling..... 7 606 kWth
Max chilled water or district cooling... 5 062 kWch/1 439 TR

Data is given at 100% load at an ambient temperature of 25°C and methane number of 80, p.f.=0.8. According to ISO 3046:1995.
Max abs-chiller COP=1.3

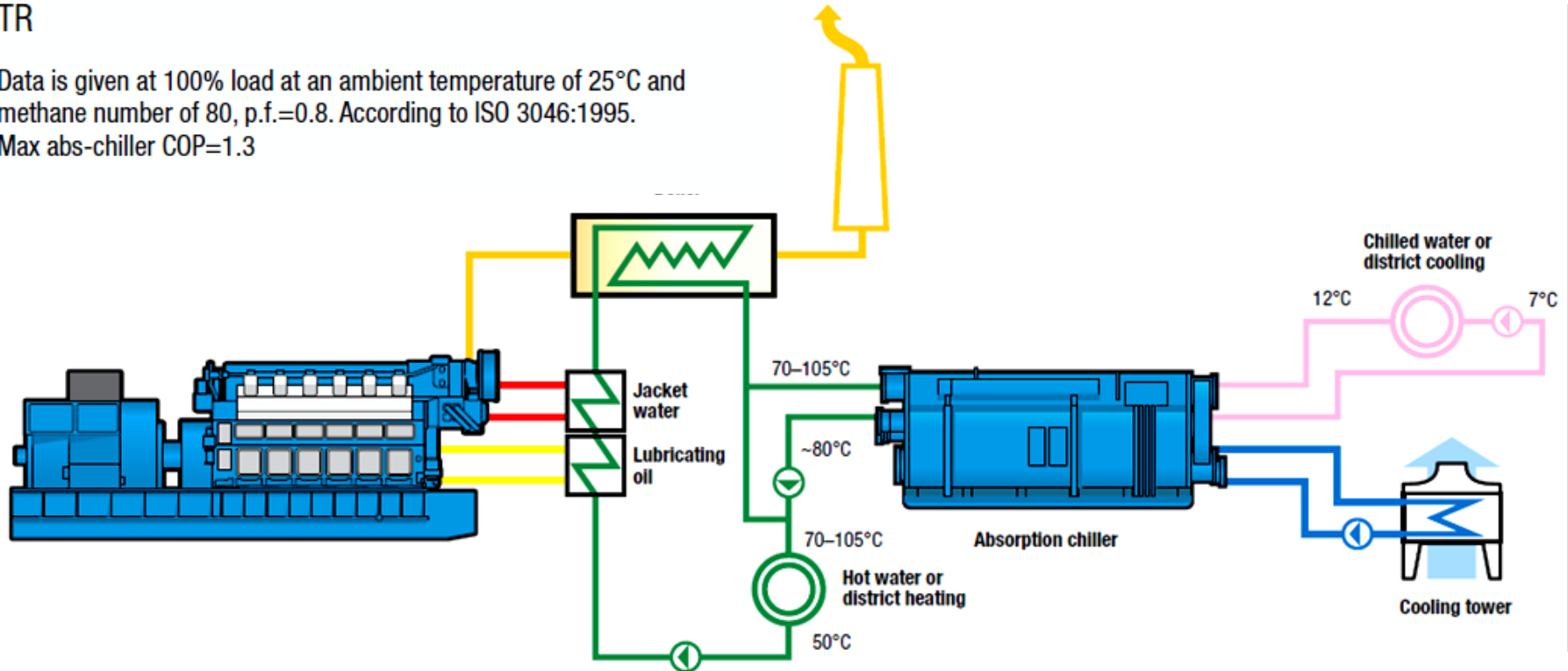

Tri-Generation solution Simultaneous generation of heat and chilled water

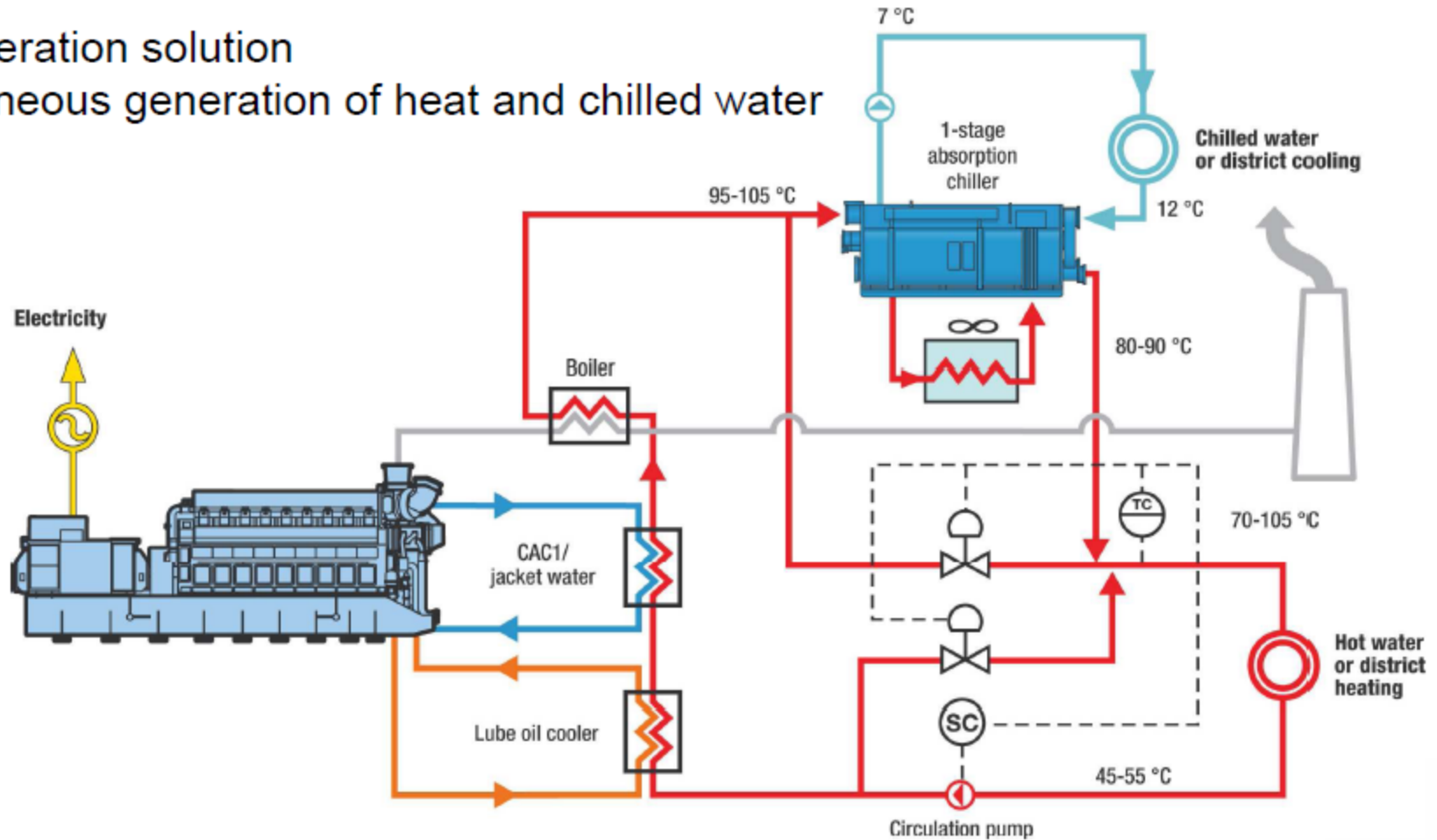

AGENDA

- W-Power in Italy
- PHC - Power Heat and Chilling
- **Linate Airport Case**
- Conclusions

Why TRIGEN in Linate Airport?

Electrical Power with grid interconnection

Airport emergency Power

ALL AVAILABLE
SIMULTANEOUSLY
HIGH EFFICIENCY
LOW EMISSIONS

Hot water for heating and Utility

Chilled water for airport air conditioning



Wärtsilä 20V34SG generator set with auxiliary modules

Inlet air/ exhaust gas module

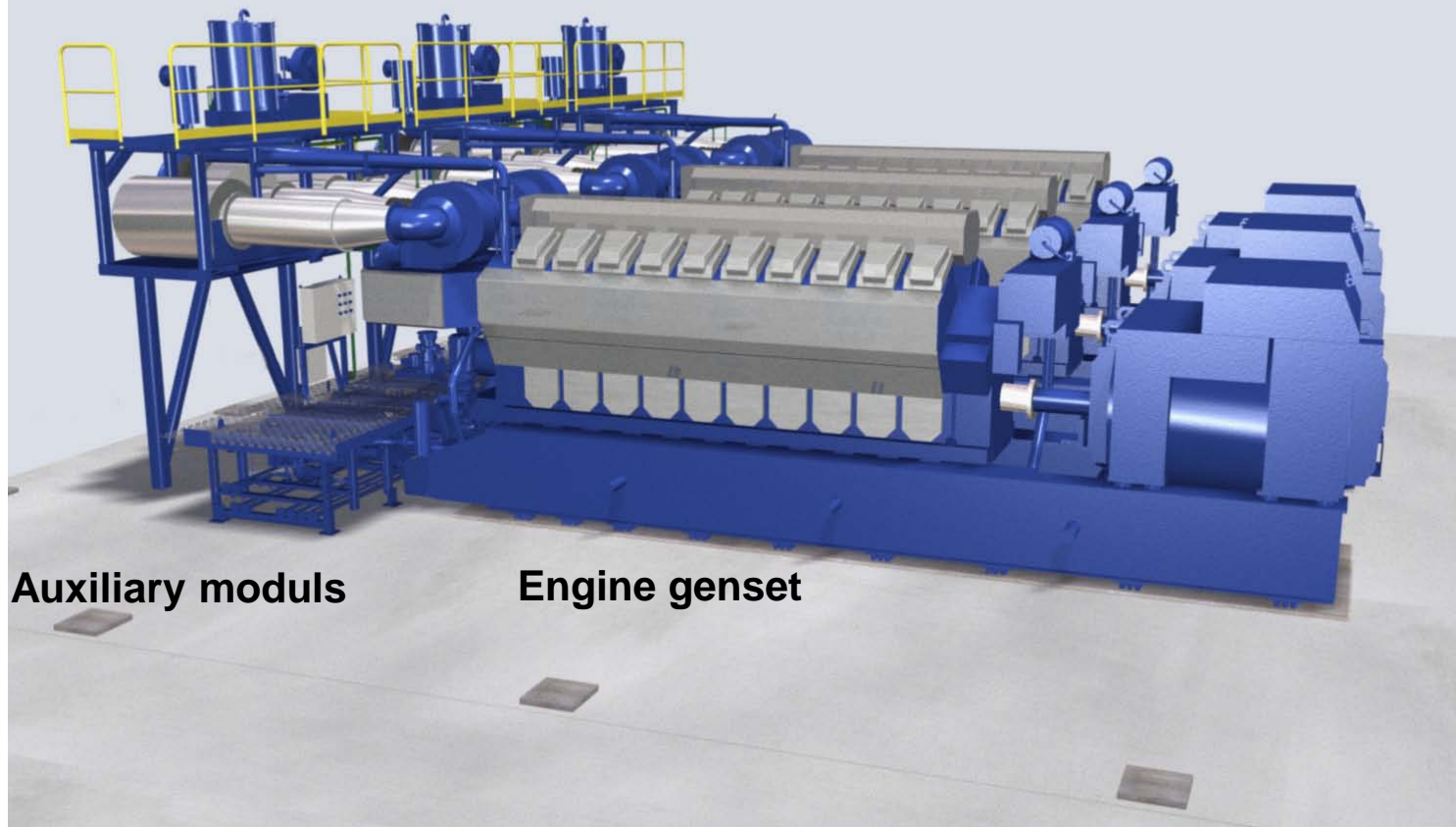

Auxiliary moduls

Engine genset

Hot Water Production – Winter time

WÄRTSILÄ FINLAND OY
Solutions Management

Malpensa Energia - Linate Airport CHP

Nominal values, tolerances +/- 10%

Made by: Jens Norrgård Mikael Frejman

Date:

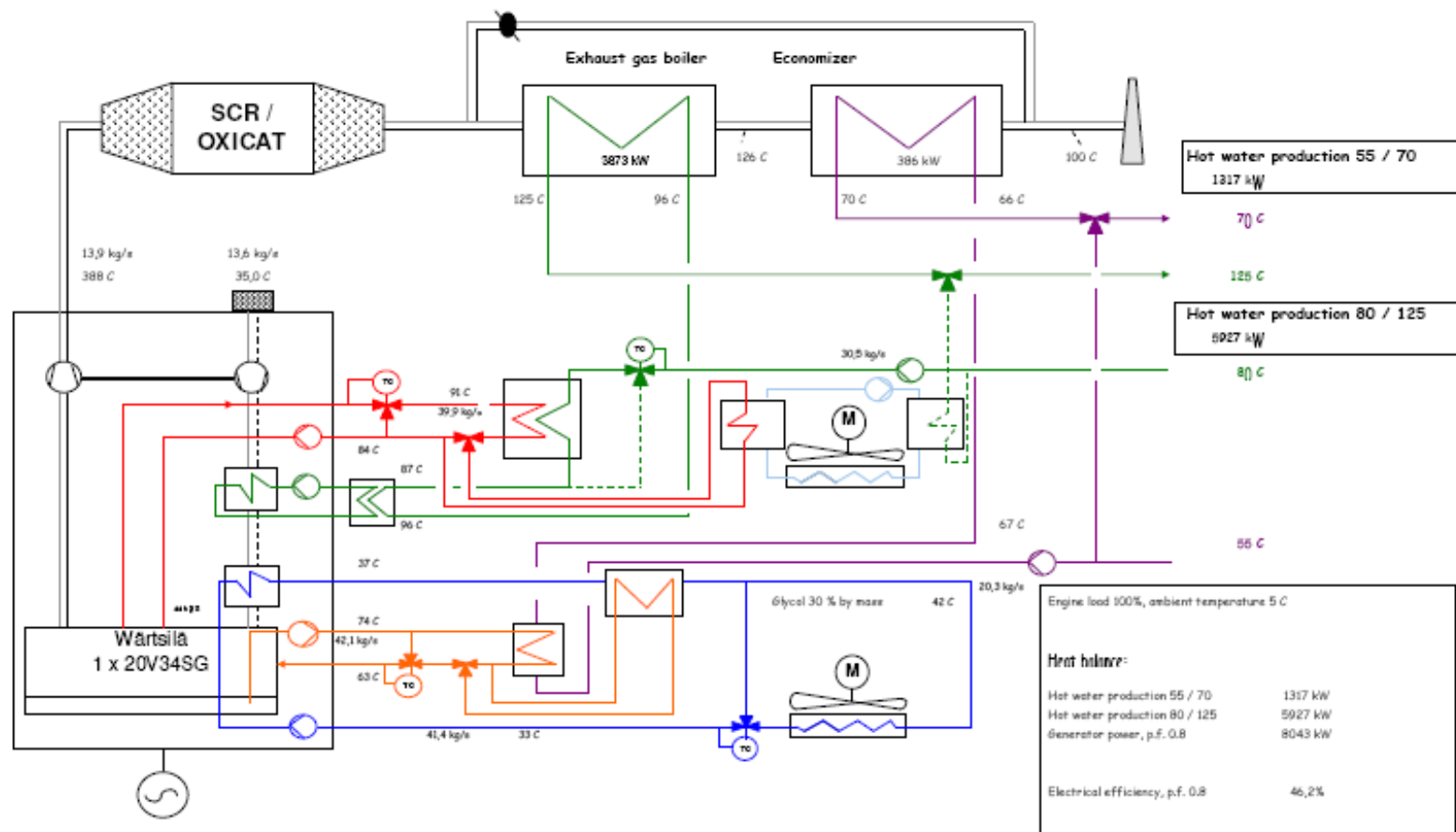

AGENDA

- W-Power in Italy
- PHC - Power Heat and Chilling
- Linate Airport Case
- **Conclusions**

- **Clean Energy**

- Energy without measurable impact locally or globally

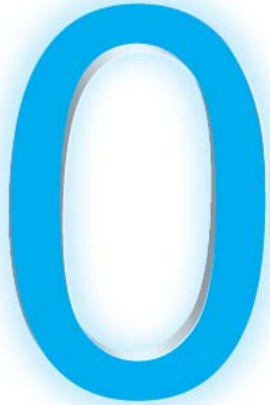

emissions

- **Sustainable source of energy**

- Available or Renewable source of energy
- High efficiency



sustainable

Sustainable and Clean Solutions

- Distributed generation
- Cogeneration
- Trigeneration
- Peaking plants
- Renewable plants

More than 1300 MW
installed in Italy

CO₂ saved >1.700.000
Ton/yr

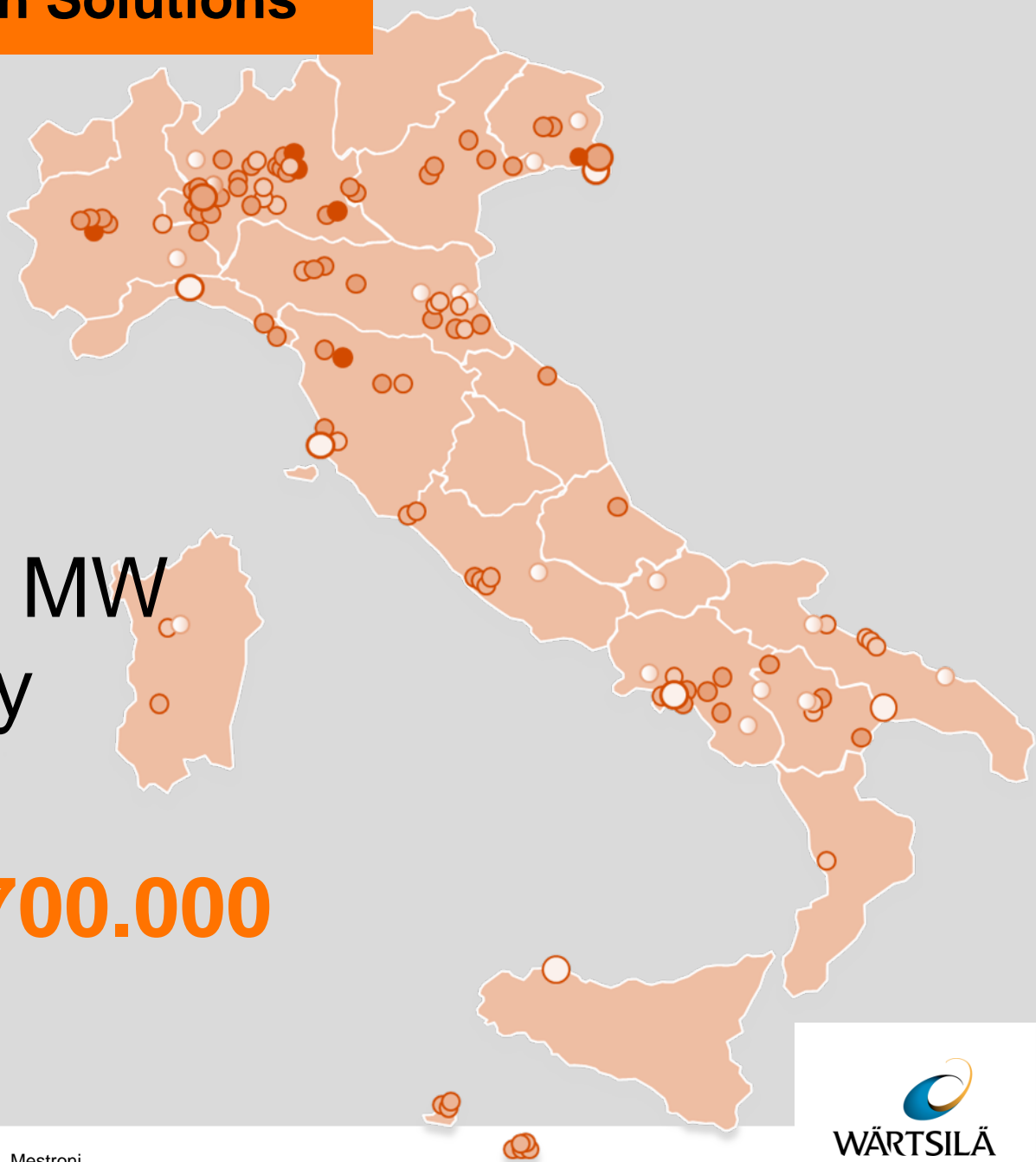

A vision based on reality...

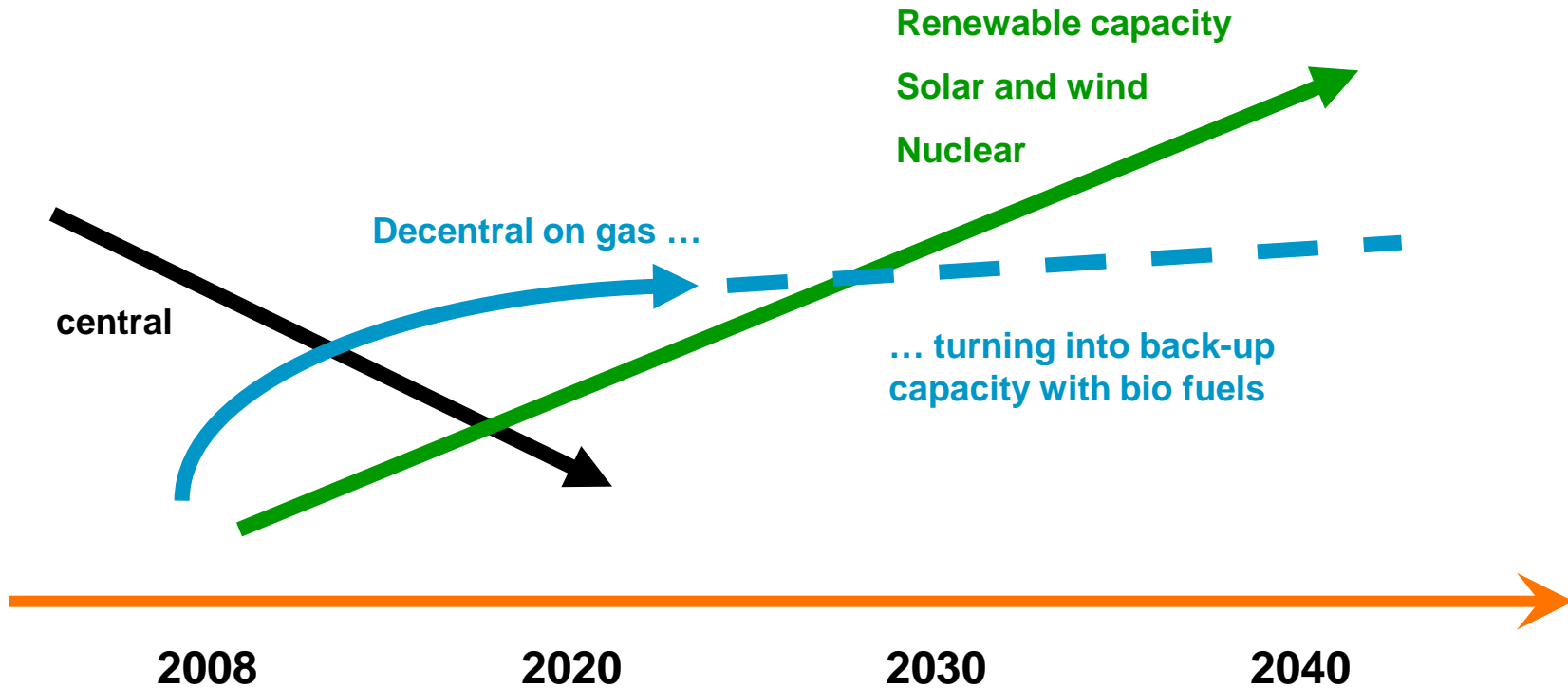

Sustainability

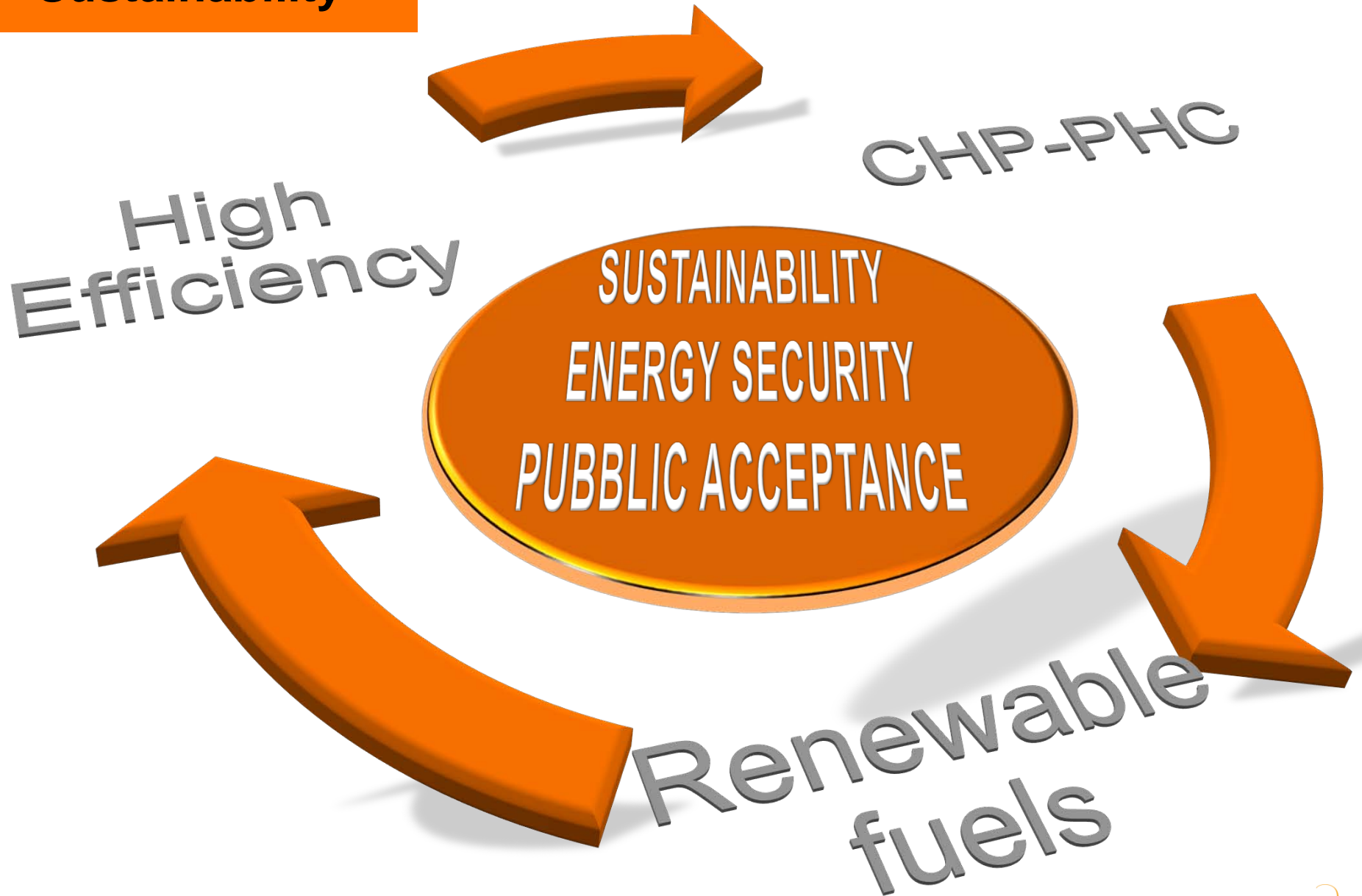

Power Plants Mission

We provide superior value to our customers with our distributed, flexible, efficient and environmentally advanced energy solutions, which enable a global transition to a more sustainable and modern energy infrastructure.



Grazie!



WÄRTSILÄ